

# NEW KEYS RELEASE 2017

**KEYLINE**  
*Innovators by design | Since 1770*  
A BIANCHI 1770 GROUP COMPANY

# NEW KEYS RELEASE 2017





**BIANCHI 1770 GROUP**

*Innovators by design | Since 1770*





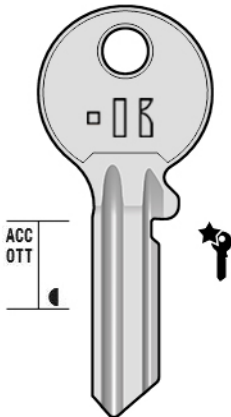
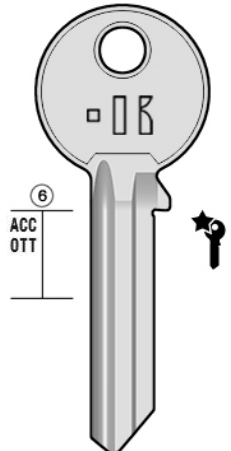
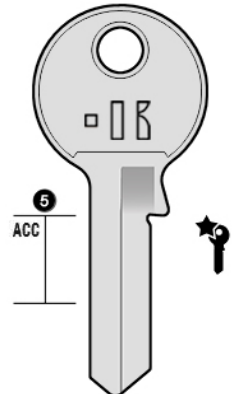
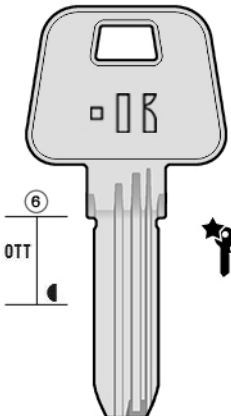



# NEW KEYS RELEASE 2017

2	606 (AR)	AGUIA (PT)	ASIA (TW)
<p><b>CROSS REFERENCE:</b></p> <p>AGU4 AG4      AG-11D</p> <p>AZ6 AZ6      AZ-9</p> <p>AZ7 AZ7      AZ-14</p> <p>BT5 BT5      BL-5</p> <p>CIN1S AS1      ASI-1</p> <p>SEI5 -          606-5D</p>	 <p style="text-align: center;">NEW SEI5</p>	 <p style="text-align: center;">NEW AGU4</p>	 <p style="text-align: center;">NEW CIN1S</p>
AZBE (E)		BLAU (DE)	
 <p style="text-align: center;">HS7 NEW AZ6</p>		 <p style="text-align: center;">NEW BT5</p>	

**Legend**

-  New profile
-  New key
-  New generation pod key (insert cap)

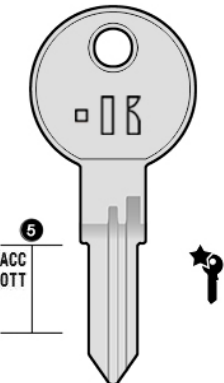
Copyright by



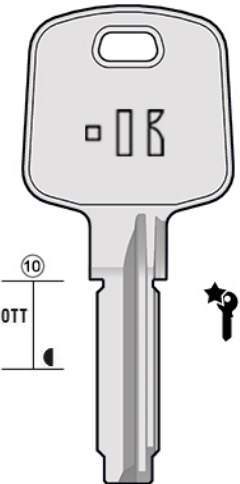
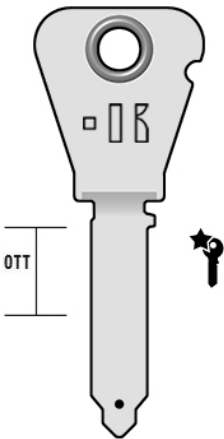
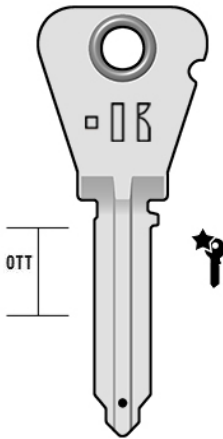

BMB (D)	BMW (D)		3
 <p><b>NEW BMB5</b></p>	 <p><b>NEW BM9TK</b></p>	 <p><b>NEW BM9U</b></p>	<p><b>CROSS REFERENCE:</b></p> <p><b>BD16</b> BD16      BRI-29</p> <p><b>BD21</b> BD21      BRI-34</p> <p><b>BD101</b> BD101     BRI-10</p> <p><b>BD102</b> BD102     BRI-12</p> <p><b>BM9TK</b> BM9TE     TP00BM-7P</p> <p><b>BM9U</b> BW9MH     BM-7.P</p> <p><b>BMB5</b> BMB5      BMB-2</p>

## BRICARD (FR)

 <p><b>NEW BD16</b></p> <p><b>NEW BD21</b></p>	 <p><b>NEW BD101</b></p>	 <p><b>NEW BD102</b></p>	<p><b>Legend</b></p> <p> New profile</p> <p> New key</p> <p> New generation pod key (insert cap)</p> <p>Copyright by</p>
---	---	--	--

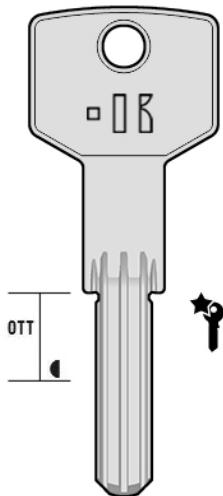
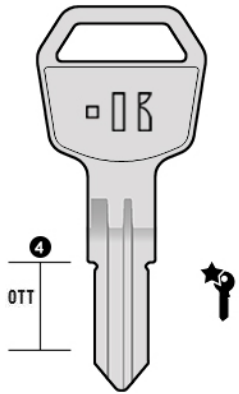
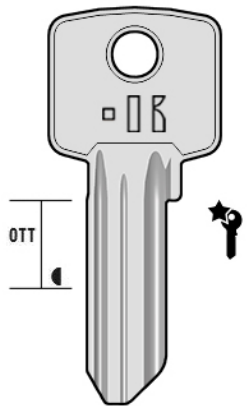



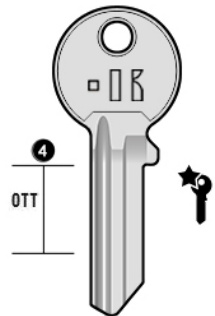
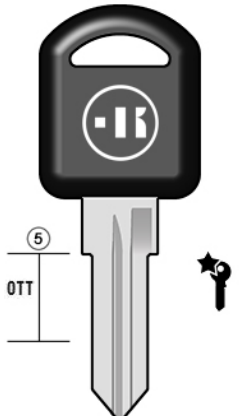
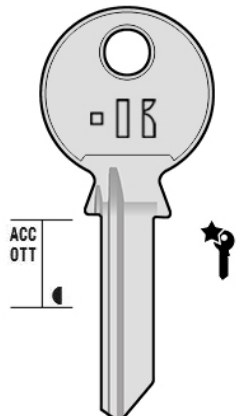

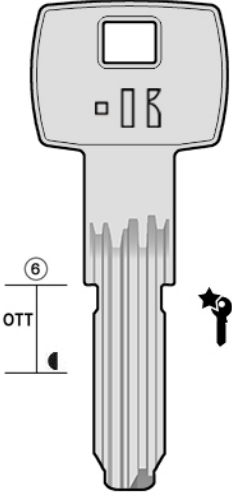
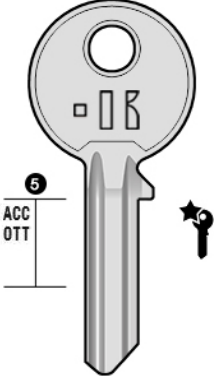
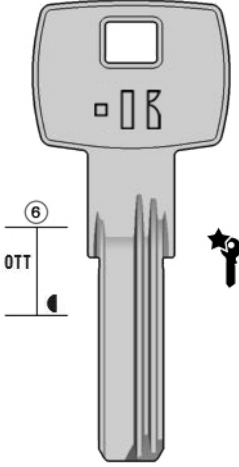
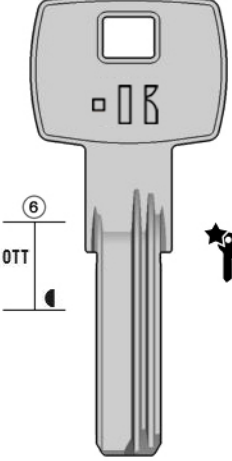
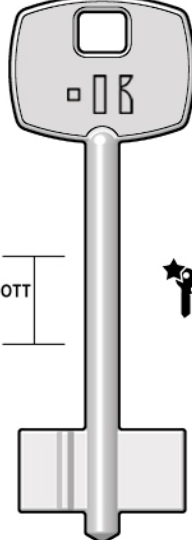
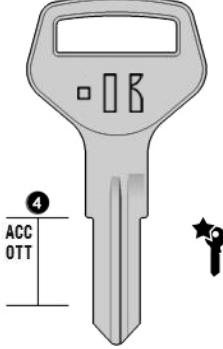
# NEW KEYS RELEASE 2017

4	BRICARD (FR)	CINA (CN)	CAS-CISMA (I)
<p><b>CROSS REFERENCE:</b></p> <p>BD110 BD11X -</p> <p>CA22 CS22 -</p> <p>CAS11 CIS12 CIS-6D</p> <p>CIN5S RC5R -</p> <p>COB2P CBR2P COB-1P</p> <p>COR61 - COR-11D</p> <p>COR61S - COR-11</p>	 <p><b>NEW</b> BD110</p>	 <p><b>NEW</b> CIN5S</p>	 <p><b>NEW</b> CAS11</p>
	CISA (I)	COBRA (I)	CORBIN (I)
<p><b>Legend</b></p> <p> New profile</p> <p> New key</p> <p> New generation pod key (insert cap)</p> <p>Copyright by</p> 	 <p><b>NEW</b> CA22</p>	 <p><b>NEW</b> COB2P</p>	 <p><b>NEW</b> COR61</p> <p><b>NEW</b> COR61S</p>

CORBIN (I)	CORNİ (I)	DEKABA (BG)	5
 <p><b>NEW</b> COR97B</p>	 <p><b>NEW</b> CR8</p>	 <p>2,32 mm Thickness <b>NEW</b> DK6</p>	<p><b>CROSS REFERENCE:</b></p> <p>2DS1 -</p> <p>COR97B CB97 COR-77</p> <p>CR8 CC8 -</p> <p>DK6 DK6 DEK-8</p> <p>DK6B -</p> <p>EVD5 -</p> <p>- -</p>
DEKABA (BG)	DOMUS (GR)	EVERGOOD (RC)	
 <p>2,50 mm Thickness <b>NEW</b> DK6B</p>	 <p><b>NEW</b> 2DS1</p>	 <p><b>NEW</b> EVD5</p>	<p><b>Legend</b></p> <p> New profile</p> <p> New key</p> <p> New generation pod key (insert cap)</p> <p>Copyright by</p>

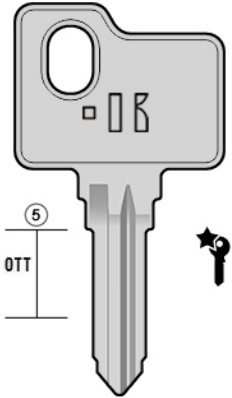
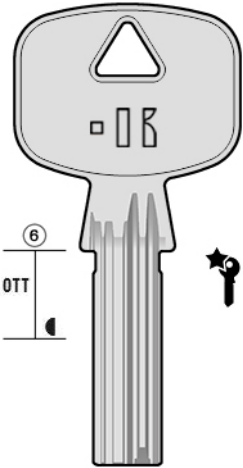
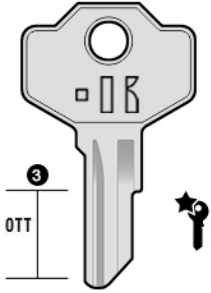
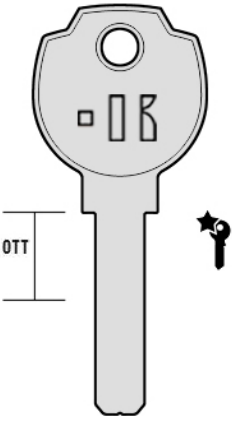
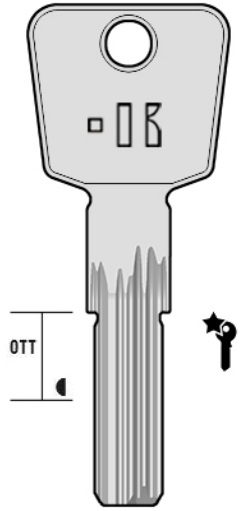
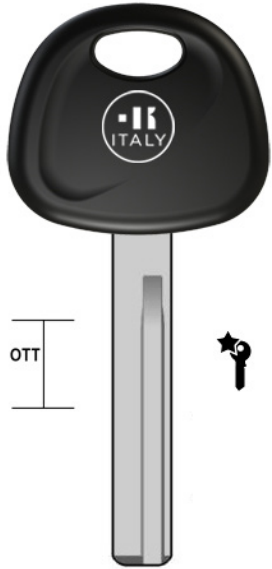

# NEW KEYS RELEASE 2017



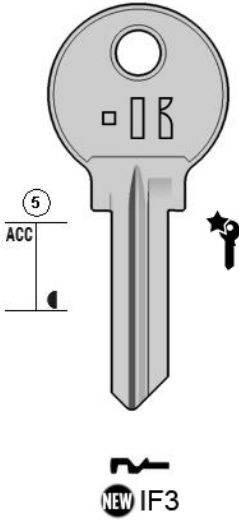
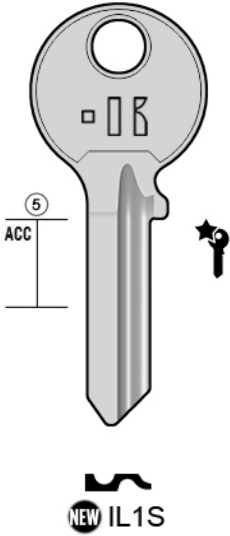
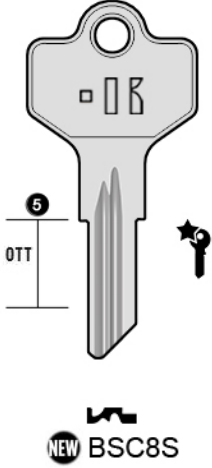
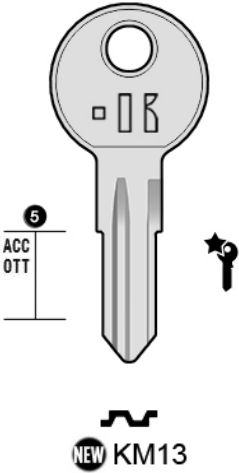
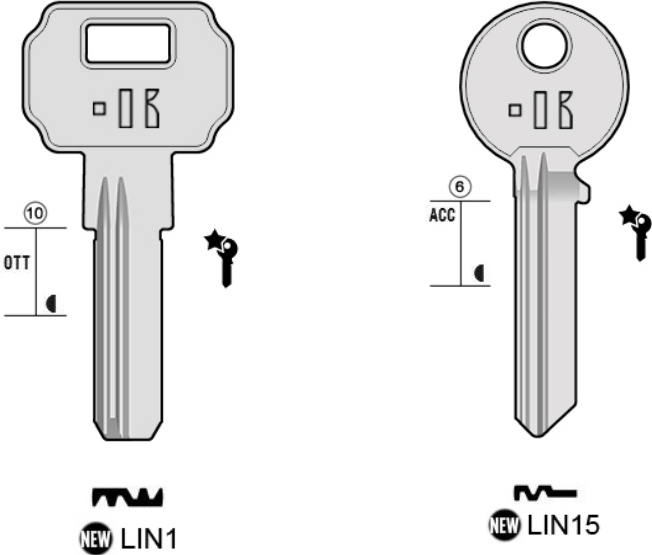







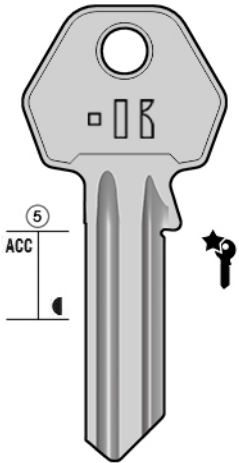

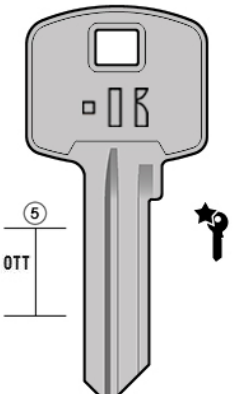









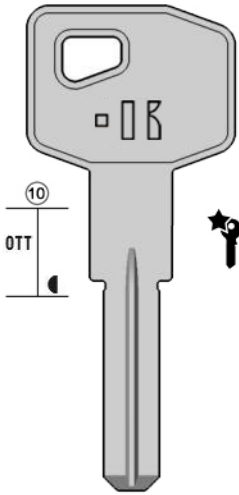

6	FARMA (I)	FCV (D)	GARELLI (I)
<p><b>CROSS REFERENCE:</b></p> <p>FARM3 FAR3      FAR-3D</p> <p>FARM3S FAR3R    FAR-3</p> <p>FV4 FV4      -</p> <p>GIS17 GS17    -</p> <p>HRC1 -        -</p> <p>HY21SBP -        -</p> <p>ZAD7 MER7R   -</p>	 <p><b>NEW FARM3</b></p> <p><b>NEW FARM3S</b></p>	 <p><b>NEW FV4</b></p>	 <p><b>NEW ZAD7</b></p>
	GIUSSANI (I)	HERACLES (FR)	HYUNDAI (ROK)
 <p><b>NEW GIS17</b></p>	 <p><b>NEW HRC1</b></p>	 <p><b>NEW HY21SBP</b></p>	
<p><b>Legend</b></p> <p> New profile</p> <p> New key</p> <p> New generation pod key (insert cap)</p> <p>Copyright by</p> <p> <b>KEYLINE</b></p>			

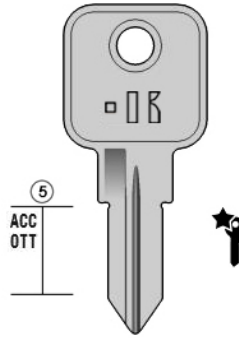
IFAM (E)	ILARGI (E)	KENWORTH (USA)	7
			<p><b>CROSS REFERENCE:</b></p> <p>BSC8S BA8R           KEN-1</p> <p>KM13 KI13           LAS-P</p> <p>LIN1 -               LIN-21D</p> <p>LIN15 LC15           LIN-16D</p> <p>IF3 IF3           IF-45/55</p> <p>IL1S IL1           IL-11</p>
KIFERM		LINCE (E)	
			<p><b>Legend</b></p> <p> New profile</p> <p> New key</p> <p> New generation pod key (insert cap)</p> <p>Copyright by</p>

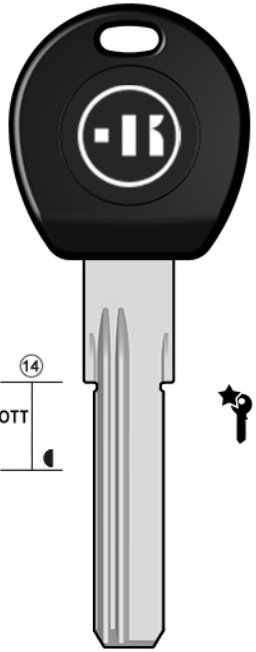



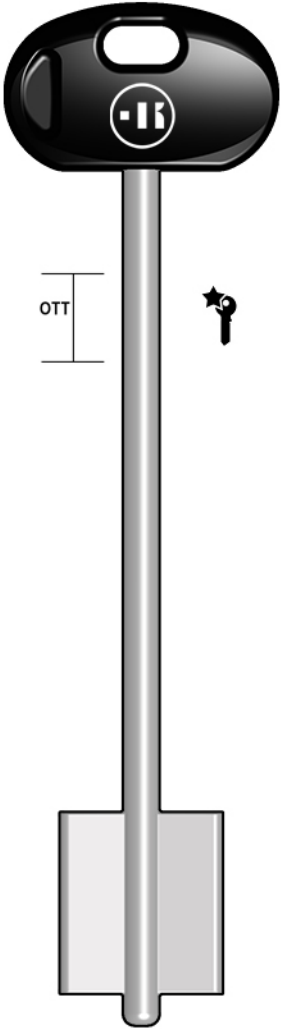
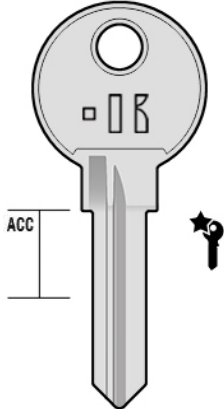
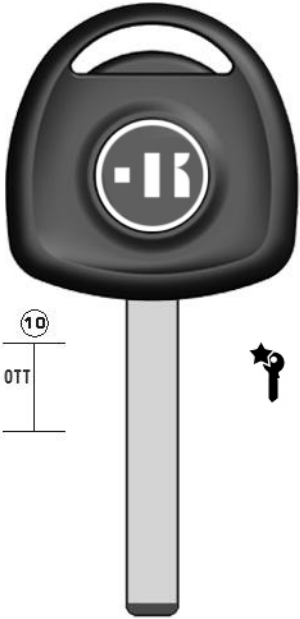
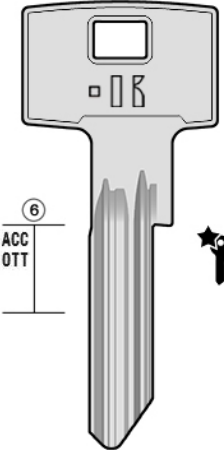
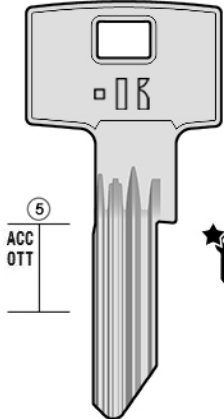

# NEW KEYS RELEASE 2017

8	LIPS (NL)	MERONI (I)	
<p><b>CROSS REFERENCE:</b></p> <p><b>ME9S</b> MER-5I  <b>MER9R</b> MER-5I  <b>ME10S</b> MER-2I  <b>MER10R</b> MER-2I  <b>ME11S</b> MER-3I  <b>MER11R</b> MER-3I  <b>ME12S</b> MER-4I  <b>MER12R</b> MER-4I  <b>ME13S</b> MER-14I  <b>MER13R</b> MER-14I  <b>ME14S</b> MER-9I  <b>MER14R</b> MER-9I  <b>ME15S</b> MER-13I  <b>MER15R</b> MER-13I  <b>ME16S</b> MER-6I  <b>MER16R</b> MER-6I  <b>ME17S</b> MER-7I  <b>MER17R</b> MER-7I  <b>ME18S</b> MER-8I  <b>MER18R</b> MER-8I  <b>ME20S</b> MER-11I  <b>MER20R</b> MER-11I  <b>ME21S</b> MER-12I  <b>MER21R</b> MER-12I  <b>MLM1S</b> MLM-5D  <b>MLM1R</b> MLM-5D  <b>MN9</b> MGA-3  <b>MG8</b> MGA-3  <b>MOI1P</b> -  <b>MOI1RP</b> -  <b>LI3</b> -  <b>LI3S</b> -  <b>LI3S</b> -</p>	  	            	
	MG MONTI (I)	MLM (F)	MOIA (I)
	 	 	 
<p><b>Legend</b></p> <p> New profile</p> <p> New key</p> <p> New generation pod key (insert cap)</p> <p>Copyright by</p> 			

MOTTURA (I)	OJMAR (E)	OPEL (D)	9																														
 <p>NEW 2MO15P</p>	 <p>NEW OJ17S</p>	 <p>NEW VX5P</p>	<p><b>CROSS REFERENCE:</b></p> <table border="0"> <tr><td>2MO15P</td><td>-</td></tr> <tr><td>PFA22S</td><td>-</td></tr> <tr><td>PHF22R</td><td>PFA-21</td></tr> <tr><td>PFA30</td><td>-</td></tr> <tr><td>-</td><td>PFA-22D</td></tr> <tr><td>PFA30S</td><td>-</td></tr> <tr><td>-</td><td>PFA-22</td></tr> <tr><td>PFA31</td><td>-</td></tr> <tr><td>-</td><td>PFA-6D</td></tr> <tr><td>PFA31S</td><td>-</td></tr> <tr><td>-</td><td>PFA-6</td></tr> <tr><td>OJ17S</td><td>OJ-19</td></tr> <tr><td>OJ17R</td><td>OJ-19</td></tr> <tr><td>VX5P</td><td>-</td></tr> <tr><td>-</td><td>-</td></tr> </table>	2MO15P	-	PFA22S	-	PHF22R	PFA-21	PFA30	-	-	PFA-22D	PFA30S	-	-	PFA-22	PFA31	-	-	PFA-6D	PFA31S	-	-	PFA-6	OJ17S	OJ-19	OJ17R	OJ-19	VX5P	-	-	-
2MO15P	-																																
PFA22S	-																																
PHF22R	PFA-21																																
PFA30	-																																
-	PFA-22D																																
PFA30S	-																																
-	PFA-22																																
PFA31	-																																
-	PFA-6D																																
PFA31S	-																																
-	PFA-6																																
OJ17S	OJ-19																																
OJ17R	OJ-19																																
VX5P	-																																
-	-																																
PFAFFENHAIN (D)																																	
 <p>NEW PFA22S</p> <p>NEW PFA31</p> <p>NEW PFA31S</p>		 <p>NEW PFA30</p> <p>NEW PFA30S</p>																															
<p><b>Legend</b></p> <ul style="list-style-type: none"> <li> New profile</li> <li> New key</li> <li> New generation pod key (insert cap)</li> </ul> <p>Copyright by</p>																																	

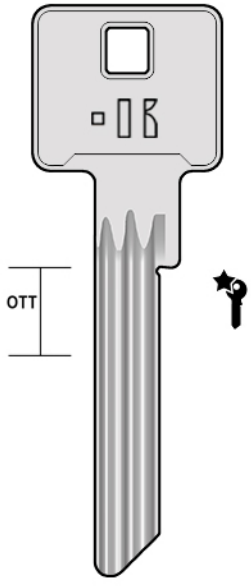
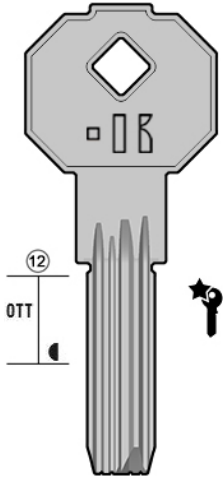
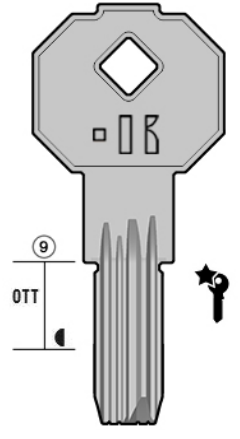
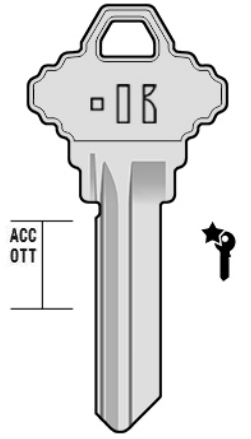
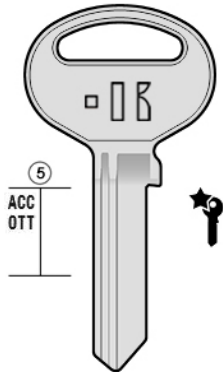

# NEW KEYS RELEASE 2017

10	POTENT (I)	PREFER (I)	
<p><b>CROSS REFERENCE:</b></p> <p>POT6 -</p> <p>PR17 -</p> <p>PF21 PR-21</p> <p>PR18 -</p> <p>PF22 -</p> <p>SC40S -</p> <p>STA10 -</p> <p>STA10 STA-3D</p> <p>STA10S -</p> <p>STA10R STA-3</p> <p>SU17STK -</p> <p>SZ11TE TP00SUZU-8IP1</p>	 <p style="text-align: center;"><b>NEW POT6</b></p>	 <p style="text-align: center;"><b>NEW PR17</b></p>	 <p style="text-align: center;"><b>NEW PR18</b></p>
<b>SCHLAGE (USA)</b>		<b>STAR (JP)</b>	<b>SUZUKI (J)</b>
 <p style="text-align: center;"><b>NEW SC40S</b></p>		 <p style="text-align: center;"><b>NEW STA10</b></p>  <p style="text-align: center;"><b>NEW STA10S</b></p>	 <p style="text-align: center;"><b>NEW SU17STK</b></p>
<p><b>Legend</b></p> <p> New profile</p> <p> New key</p> <p> New generation pod key (insert cap)</p> <p>Copyright by  <b>KEYLINE</b></p>			

TESA (E)	TIGRIS (GB)	TOK-WINKHAUS (D)	11
<p><b>NEW TES17</b></p>	<p><b>NEW TIG1</b></p>	<p><b>NEW TK10SL</b></p>	<p><b>CROSS REFERENCE:</b></p> <ul style="list-style-type: none"> <li>TC1D-SLM -</li> <li>TC1S-SLM -</li> <li>TC2D-SLM -</li> <li>TC2S-SLM -</li> <li>TC3D-SLM -</li> <li>TC3S-SLM -</li> <li>TC5D-SLM -</li> <li>TC5S-SLM -</li> <li>TES17</li> <li>TE19 TE-T62</li> <li>TIG1</li> <li>TG1 TIG-1D</li> <li>TK10SL</li> <li>TK120RX -</li> </ul>

## TRI-CIRCLE (RC)

**NEW TC1D-SLM**

**NEW TC5D-SLM**

**NEW TC1S-SLM**

**NEW TC5S-SLM**

1,50 mm Thickness

**NEW TC2D-SLM**

1,50 mm Thickness

**NEW TC2S-SLM**

1,50 mm Thickness

**NEW TC3D-SLM**

1,50 mm Thickness

**NEW TC3S-SLM**











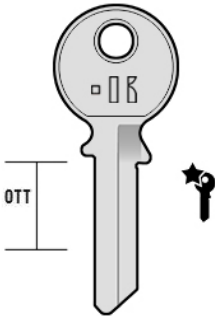

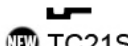
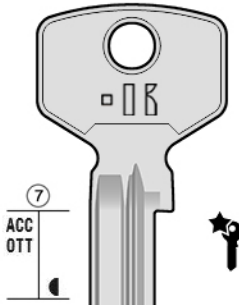
**Legend**

- New profile
- New key
- New generation pod key (insert cap)

Copyright by



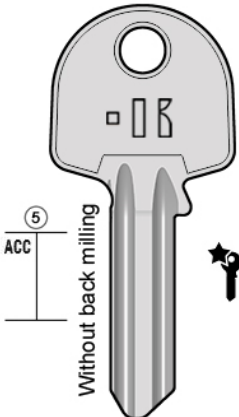

# NEW KEYS RELEASE 2017

12	TRI-CIRCLE (RC)	TRIOVING (N)	UNIVERSAL
<b>CROSS REFERENCE:</b>			
TC21D - TRI-21D	   	        	  
TV8 TR8 TV-2D			
TV10 TR10 TV-23D			
TV10S TR10R TV-23			
TV12 TR12 TV-17D			
TV13S TR13R TV-30			
TV24 -			
TV31 - TV-13			
TV32S - TV-32			
UN4S-SLM -			
UN5D-DX -			
UN5S-DX -			
UN5S-SLM UL051 Rhino			
UN6S-SLM -			

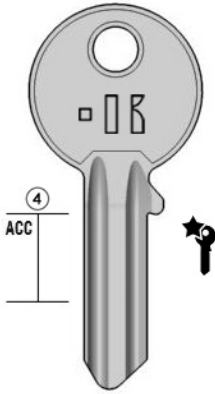
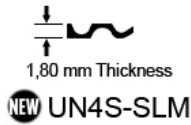
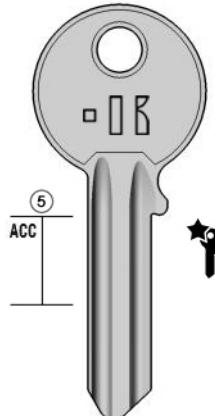
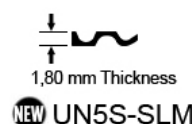
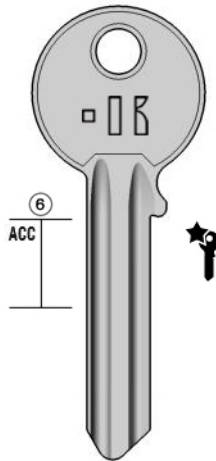
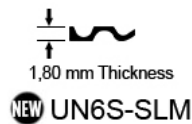
## UNIVERSAL SLIM

 	 	 
--	---	--

**Legend**

-  New profile
-  New key
-  New generation pod key (insert cap)

Copyright by

VIRO (I)		VIS (I)		13
<p>4 OTT NEW VR17</p>		<p>OTT NEW VR25S</p>		<p><b>CROSS REFERENCE:</b></p> <p>2YE1 5YA1      YA-1G</p> <p>VR17 VI17      -</p> <p>VR25S -      -</p> <p>VS9 VS090V      -</p> <p>YE70 YA70R      YA-53</p> <p>YE71L YA90      YA-81</p>
<p>5 OTT NEW VS9</p>		<p>OTT NEW VS9</p>		
YALE (D)		YALE (GB)		YALE (I)
<p>6 ACC OTT NEW YE70</p>		<p>OTT NEW 2YE1</p>		<p>6 OTT NEW YE71L</p>
<p><b>Legend</b></p> <p> New profile</p> <p> New key</p> <p> New generation pod key (insert cap)</p> <p>Copyright by</p>				



# NEW KEYS RELEASE 2017

14

YALE SLIM

**CROSS REFERENCE:**

- YE4D-SLM -
- YE4S-SLM -
- YE5S-SLM -
- YE6S-SLM -
- ZAD11 -
- ZD9      ZA-1

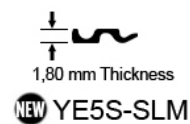
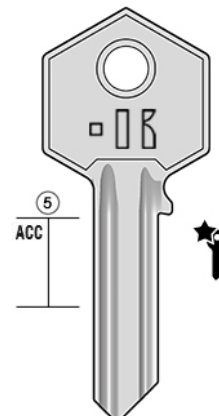
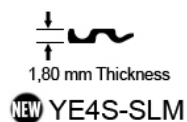
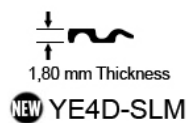
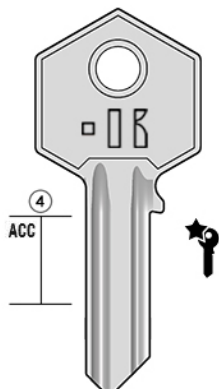

YALE SLIM

ZADI (I)

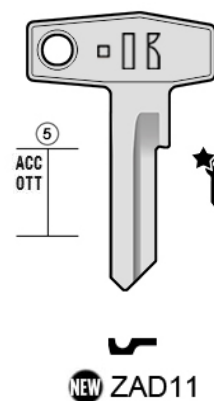
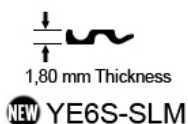
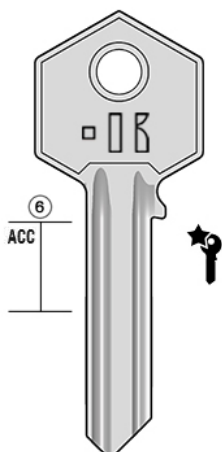

**Legend**

- New profile
- New key
- New generation pod key (insert cap)

Copyright by



KL Reference	Make	Model	From	To	Transponder
<b>BM9TK</b>	BMW (D)	C600 Sport	2012	-	Philips® Crypto - PH20
	BMW (D)	C650 GT	2012	-	Philips® Crypto - PH20
	BMW (D)	F650	2008	2011	Philips® Crypto - PH20
	BMW (D)	F800	2006	-	Philips® Crypto - PH20
	BMW (D)	G650	2011	-	Philips® Crypto - PH20
	BMW (D)	K1200	2005	2008	Philips® Crypto - PH20
	BMW (D)	K1300	2009	-	Philips® Crypto - PH20
	BMW (D)	K1600	2011	-	Philips® Crypto - PH20
	BMW (D)	R1200	2005	-	Philips® Crypto - PH20
<b>BM9U</b>	BMW (D)	C600 Sport	2012	-	Philips® Crypto - PH20
	BMW (D)	C650 GT	2012	-	Philips® Crypto - PH20
	BMW (D)	F650	2008	2011	Philips® Crypto - PH20
	BMW (D)	F800	2006	-	Philips® Crypto - PH20
	BMW (D)	G650	2011	-	Philips® Crypto - PH20
	BMW (D)	K1200	2005	2008	Philips® Crypto - PH20
	BMW (D)	K1300	2009	-	Philips® Crypto - PH20
	BMW (D)	K1600	2011	-	Philips® Crypto - PH20
	BMW (D)	R1200	2005	-	Philips® Crypto - PH20
<b>BSC8S</b>	KENWORTH (USA)	Some models	1950	1987	-
	INTERNATIONAL (truck)	Some models	1940	1975	-
	JEEP (USA)	Some models	1940	1973	-
	MACK	Some models	1955	1969	-
	PETERBUILT (truck)	Some models	-	-	-
<b>HY21SBP</b>	HYUNDAI (ROK)	Some models	-	-	-
<b>SU17STK</b>	MARUTI SUZUKI	Alto	2007	2010	Texas® Crypto - TCXX
	SUZUKI (J)	Alto	2000	2008	Texas® Crypto - TCXX
<b>VX5</b>	OPEL (D)	Some models	-	-	-
<b>ZAD7</b>	GARELLI (I)	Some models	-	1991	-
<b>ZAD11</b>	APRILIA (I)	125	1990	1991	-
	APRILIA (I)	AFI	1986	1991	-
	APRILIA (I)	ET	1986	1991	-
	APRILIA (I)	ETX	1986	1991	-
	APRILIA (I)	Europa	1992	1992	-
	APRILIA (I)	Extrema	1993	1994	-
	APRILIA (I)	MX	1986	1991	-
	APRILIA (I)	Pegaso	1990	1994	-
	APRILIA (I)	Rare Valve	1986	1991	-





# NEW KEYS RELEASE 2017

## APPLICATIONS CAR KEYS

16

KL Reference	Make	Model	From	To	Transponder
<b>ZAD11</b>	APRILIA (I)	Red Rose	1986	1989	-
	APRILIA (I)	RX	1992	1995	-
	APRILIA (I)	Tuareg	1986	1991	-
	BETAMOTOR (I)	50	1980	1993	-
	CAGIVA (I)	W 12 350	1994	1996	-
	CAGIVA (I)	W 16	1994	-	-
	GARELLI (I)	Formuno	1988	1991	-
	GARELLI (I)	Gary	1988	1994	-
	GILERA (I)	503	1993	1994	-
	GILERA (I)	AE	1993	1994	-
	GILERA (I)	Arizona	1988	1994	-
	GILERA (I)	Bullit	1992	1994	-
	GILERA (I)	CX	1988	1991	-
	GILERA (I)	Dakota	1988	1990	-
	GILERA (I)	NGR	1988	1990	-
	GILERA (I)	RC	1991	1994	-
	GILERA (I)	RTX	1980	1993	-
	GILERA (I)	RV	1980	1993	-
	GILERA (I)	RX	1980	1993	-
	GILERA (I)	Sloux	1993	1994	-
	MOTO GUZZI (I)	Nevada	1995	-	-

To find the distributor closest to your company,  
please send a request to:



#### Keyline

Keyline S.p.A.  
Via Camillo Bianchi, 2 - P.O. Box 251  
31015 Conegliano (TV) Italy  
T +39 0438 202 511  
F +39 0438 202 520  
info@keyline.it  
www.keyline.it



#### Bianchi 1770 Group Companies distributing Keyline products

##### Keyline USA

Bianchi USA, Inc.  
31336 Industrial Pkwy - Suite 3  
North Olmsted, Ohio 44070, USA  
T +1 440 716 8006  
F +1 216 803 0202  
TF +1 800 891 2118  
info@keyline-usa.com  
www.keyline-usa.com

##### Keyline Italia

Keyline Italia S.r.l.  
Via Zoe Fontana, 220 - Ed. C  
Tecnocittà  
00131 Roma, Italy  
T +39 06 4122 9822  
F +39 06 4120 0981  
info@keyline-italia.it  
www.keyline-italia.it

##### Keyline Shanghai

Bianchi 1770 Hardware Technology (Shanghai) Co. Ltd  
比安奇五金技术（上海）有限公司  
中国上海市虹口区黄浦路  
上海滩国际大厦  
Room 1505, Shanghai Bund International Tower  
No.99 Huangpu Road, Hong Kou District 200080  
Shanghai P.R. China  
T +86 021 5031 0980  
F +86 021 5031 0981  
info@keyline-shanghai.com  
www.keyline-shanghai.com

##### Keyline Germany

Keyline GmbH  
Uhlandstraße 31b  
42549 Velbert, Germany  
T +49 (0) 2051 807 4444  
F +49 (0) 2051 606 9922  
info@keyline-germany.de  
www.keyline-germany.de

#### Bianchi 1770 Group Representative Offices coordinating onsite distributors

##### Keyline UK

18 Beeston Court - Stuart Road  
Manor Park - Runcorn - Cheshire  
WA7 1SS - UK  
T +44 (0) 1928 597 755  
info@keyline-uk.co.uk  
www.keyline-uk.co.uk

##### Keyline Japan

〒532-0011  
大阪府大阪市淀川区西中島4-7-20  
日宝新大阪第1ビル4階1号  
Room 4F-1 Nippo Shin-Osaka Daiich Building  
4-7-20 Nishinakajima, Yodogawa-ku Osaka City  
Osaka 532-0011, Japan  
T +81 6 4805 6969  
F +81 6 4805 6900  
info@keyline-japan.jp  
www.keyline-japan.jp